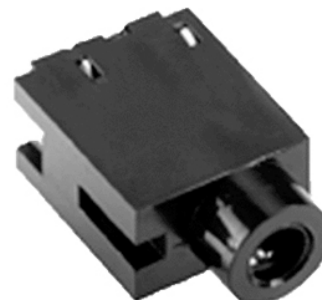

**MODEL:** SJ-2504N | **DESCRIPTION:** AUDIO JACK**FEATURES**

- 2.5 mm stereo
- right angle
- through hole
- 3 conductors
- 1 internal switch

**SPECIFICATIONS**

parameter	conditions/description	min	typ	max	units
rated input voltage			12		Vdc
rated input current				1	A
contact resistance <sup>1</sup>	between terminal and contact between terminal and mating plug			30 50	mΩ mΩ
insulation resistance	at 500 Vdc	100			MΩ
voltage withstand	for 1 minute			500	Vac
insertion force	when mating with a standard jack	0.3		2	kgf
withdrawal force	when mating with a standard jack	0.3		2	kgf
operating temperature		-20		60	°C
storage temperature		-25		70	%
life			5,000		cycles
flammability rating	UL94V-0				
RoHS	yes				

Note: 1. When measured at a current of less than 100 mA/1 kHz  
2. All specifications measured at 5~35°C, humidity at 45~85%, under standard atmospheric pressure, unless otherwise noted.

**SOLDERABILITY**

parameter	conditions/description	min	typ	max	units
wave soldering				265	°C

## MECHANICAL DRAWING

units: mm[inch]  
 tolerance:  
 X.X ±0.5 mm  
 X.XX ±0.3 mm  
 X.XXX ±0.15 mm  
 PCB: ±0.1 mm

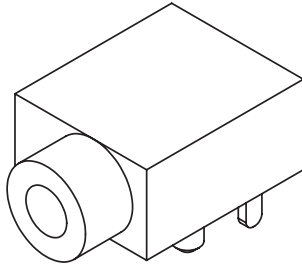

ITEM	DESCRIPTION	MATERIAL	PLATING/COLOR
1	sleeve	PBS	matte tin
2	tip shunt	brass	matte tin
3	tip	PBS	matte tin
4	ring	PBS	matte tin
5	housing	PBT	black

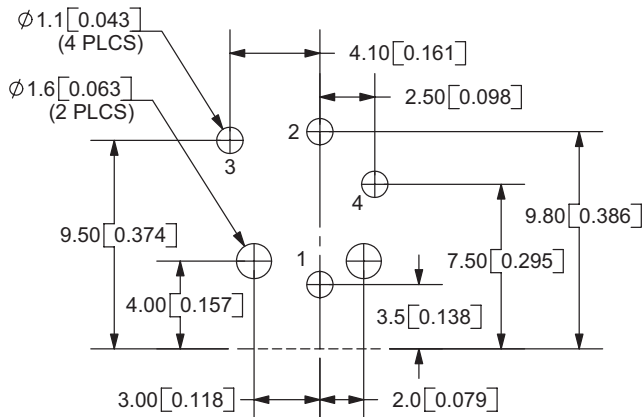
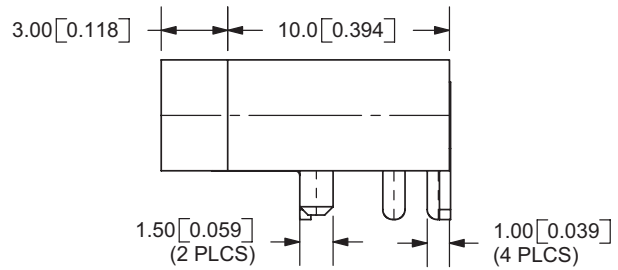
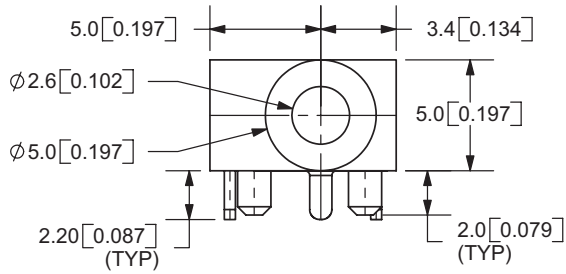

Recommended PCB Layout  
Top View

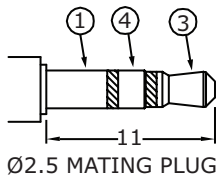
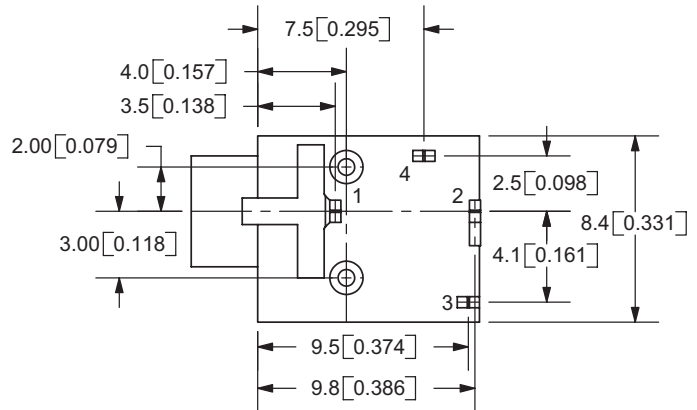

Schematic	
PIN	
1	sleeve
2	tip switch
3	tip
4	ring

## REVISION HISTORY

---

rev.	description	date
1.0	initial release	12/05/2005
1.01	brand update	01/20/2021

The revision history provided is for informational purposes only and is believed to be accurate.

---

# CUI DEVICES

CUI Devices offers a one (1) year limited warranty. Complete warranty information is listed on our website.

CUI Devices reserves the right to make changes to the product at any time without notice. Information provided by CUI Devices is believed to be accurate and reliable. However, no responsibility is assumed by CUI Devices for its use, nor for any infringements of patents or other rights of third parties which may result from its use.

CUI Devices products are not authorized or warranted for use as critical components in equipment that requires an extremely high level of reliability. A critical component is any component of a life support device or system whose failure to perform can be reasonably expected to cause the failure of the life support device or system, or to affect its safety or effectiveness.