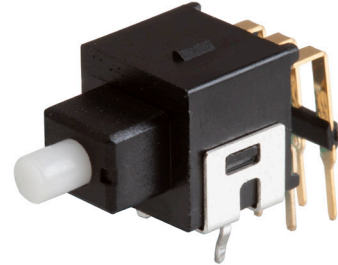

**SERIES:** MPB05 | **DESCRIPTION:** MINI PUSH BUTTON SWITCH

**FEATURES**

- double pole
- right angle
- cap options

**SPECIFICATIONS**

parameter	conditions/description	min	typ	max	units
rated voltage				28	Vdc
rated current				14	mA
withstanding voltage	for 1 minute		500		Vac
contact resistance				50	mΩ
insulation resistance	at 500 Vdc	500			MΩ
operating force		250	350	450	gf
actuator travel			1.1		mm
operating temperature		-25		80	°C
life			20,000		cycles
flammability rating	see material table				
RoHS	yes				
packaging	tray QTY: 100 pcs per tray box QTY: 1,200 pcs per box				

**SOLDERABILITY**

parameter	conditions/description	min	typ	max	units
hand soldering	for maximum 3 seconds			350	°C
wave soldering	for maximum 5 seconds			270	°C

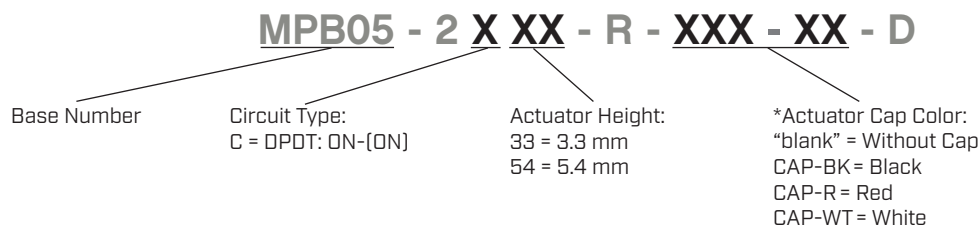
**PART NUMBER KEY**

Note: \*Actuator cap only on 5.4 mm actuator height versions.

## MECHANICAL DRAWING (DPDT CIRCUIT)

units: mm  
tolerance: ±0.3 mm  
unless otherwise noted

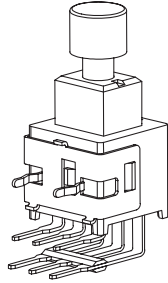

ITEM	DESCRIPTION	MATERIAL	PLATING/COLOR
1	actuator	POM (UL94HB)	white
2	housing	PA66 (UL94V-0)	black
3	terminals	brass	gold
4	bracket	phosphor bronze	tin
5	cap	POM (UL94HB)	black (BK) red (R) white (WT)

### 3.3 MM ACTUATOR

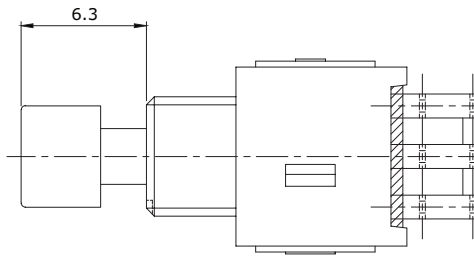
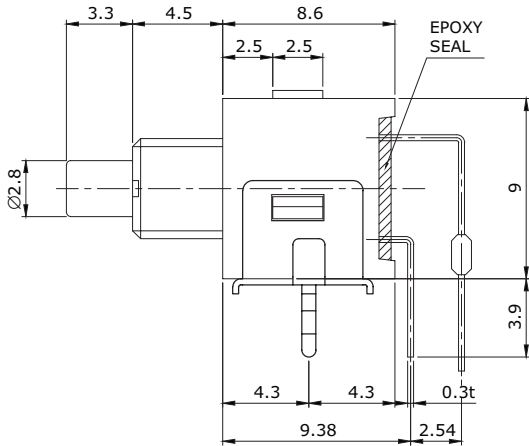

ACTUATOR POSITION [ ]: MOMENTARY	
NORMAL	DOWN
ON	[ON]
2-3	2-1
5-6	5-4

SCHEMATIC	
2 (COM)	5 (COM)
3	1
6	4

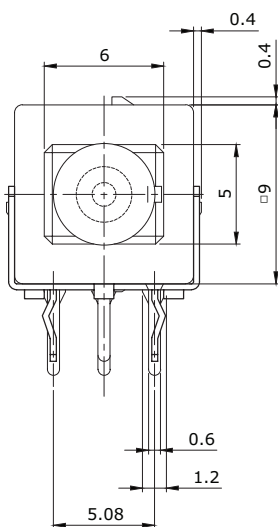

### 5.4 MM ACTUATOR

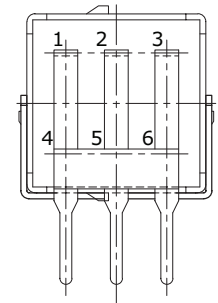
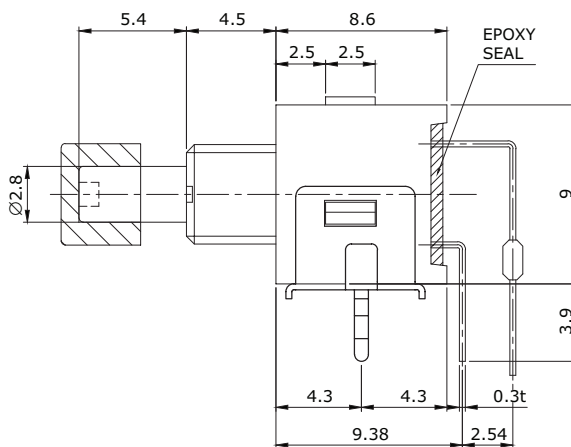

### ACTUATOR CAP

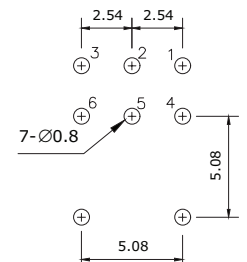
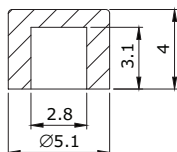

Recommended PCB Layout  
Top View

Note: \*Actuator cap only on 5.4 mm actuator height versions.

## REVISION HISTORY

rev.	description	date
1.0	initial release	06/03/2021
1.01	logo, datasheet style update	08/05/2022

The revision history provided is for informational purposes only and is believed to be accurate.



CUI Devices offers a one (1) year limited warranty. Complete warranty information is listed on our website.

CUI Devices reserves the right to make changes to the product at any time without notice. Information provided by CUI Devices is believed to be accurate and reliable. However, no responsibility is assumed by CUI Devices for its use, nor for any infringements of patents or other rights of third parties which may result from its use.

CUI Devices products are not authorized or warranted for use as critical components in equipment that requires an extremely high level of reliability. A critical component is any component of a life support device or system whose failure to perform can be reasonably expected to cause the failure of the life support device or system, or to affect its safety or effectiveness.

[cuidevices.com](http://cuidevices.com)