

PART NUMBER: EC252AB**DESCRIPTION:** rotary encoder**ELECTRICAL SPECIFICATIONS**

output waveform	Square wave
output signals	A, B phase
current consumption	20 mA max.
output voltage	V _{cc} ~ 0.5 V min.
“H”	0.7 V max.
“L”	
output current	-0.1 mA max.
supply voltage	3.3 V dc ± 5%
output resolution (ppr)	50
frequency response	100 Hz

MECHANICAL SPECIFICATIONS

max shaft load, radial:	1 kgf
axial:	1 kgf
starting torque	0.4 ±0.2 N·cm max. (41 ±20 gf·cm max.)
rotational angle	360° continuous
maximum speed	120 RPM
rotational life	1,000,000 cycles
weight	20 g

ENVIRONMENTAL SPECIFICATIONS

operating temp	0° to +60° C
storage temp	-20° to +80° C
humidity	85% RH, no condensation
vibration	10 ~ 55 Hz, 1.5 mm, 2 hours
shock	50 G, 6 ms, 3 axes, 3 reps

ORDERING INSTRUCTIONS**EC252X050X**

Detent:

A = Without detent
B = With detent

Termination options:

A = Solder holes
B = Connector
C = Cable
D = PC board mount

PART NUMBER: EC252AB

DESCRIPTION: rotary encoder

OUTPUT WAVEFORM

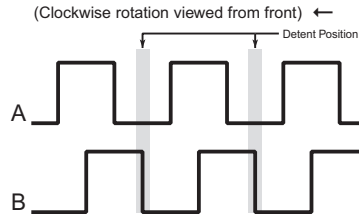

OUTPUT CIRCUIT

INTERNAL CIRCUIT

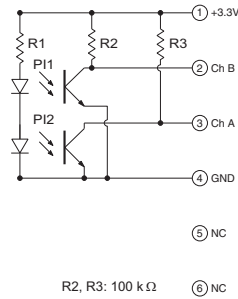

EXTERNAL CIRCUIT

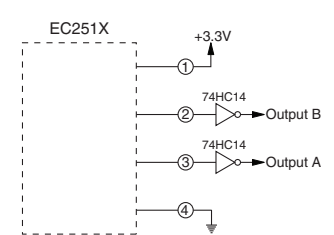

MECHANICAL DRAWING

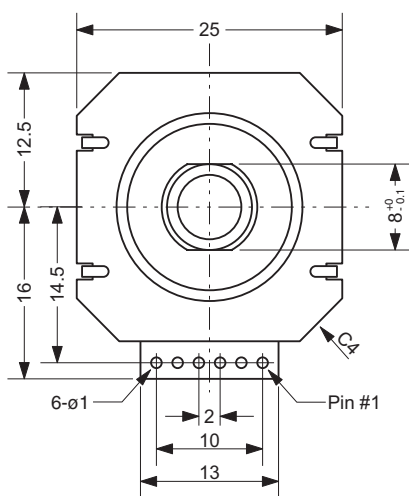

EC252X050A

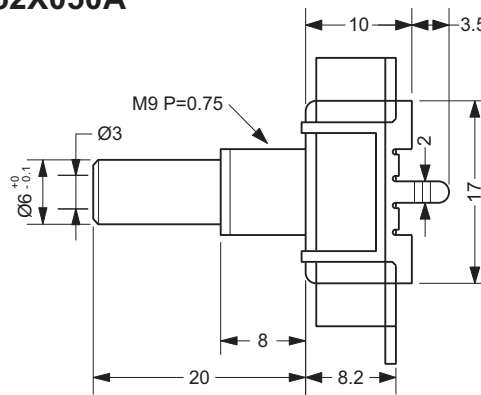

Mounting Hole Dimensions

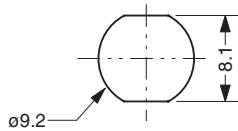

PCB Footprint

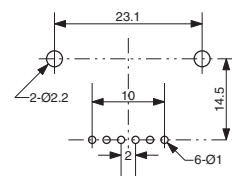

EC252X050B

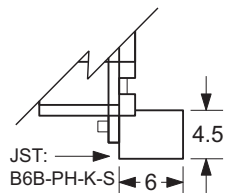

EC252X050C

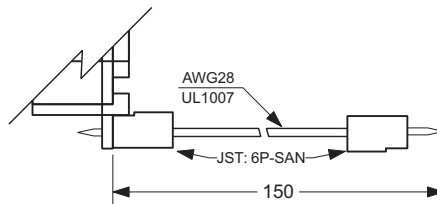

EC252X050D

