

**SERIES:** TS29 | **DESCRIPTION:** TACTILE SWITCH

**FEATURES**

- illuminated
- 5 color options
- through hole

**SPECIFICATIONS**

parameter	conditions/description	min	typ	max	units
rated voltage				12	Vdc
rated current				50	mA
withstanding voltage	for 1 minute		250		Vac
contact resistance	applying load of 2 times operating force at 5 Vdc, 10 mA			100	mΩ
insulation resistance	for 1 minute at 100 Vdc	100			MΩ
operating force		200	300	400	gf
return force		20			gf
actuator travel		0.25	0.35	0.45	mm
operating temperature		-30		80	°C
storage temperature		-40		90	°C
life	at 5 Vdc, 5 mA, 20 cycles/second, 1.5 times operating force		100,000		cycles
vibration	10~55~10 Hz, 1.5 mm amplitude, 2 hours on each XYZ				
flammability rating	see material table				
RoHS	yes				

**SOLDERABILITY**

parameter	conditions/description	min	typ	max	units
hand soldering	for maximum 3 seconds			350	°C
wave soldering	for maximum 5 seconds			260	°C

**PART NUMBER KEY**

**TS29 - 1212 - 1 - XX - 300 - D**

Base Number

LED Color:  
 WT = white  
 BL = blue  
 R = red  
 G = green  
 Y = yellow

## LED ABSOLUTE MAXIMUM RATINGS (WHITE) (TA=25°C)

parameter	conditions/description	min	typ	max	units
power dissipation [Pd]				18	mW
DC forward current [If]				5	mA
peak forward current [Ifp]	pulse of 1/10 duty and 0.1 ms width			100	mA
reverse voltage [Vr]				5	V

## LED ELECTRO-OPTICAL CHARACTERISTICS (WHITE) (TA=25°C)

parameter	conditions/description	min	typ	max	units
forward voltage [Vf]	at If=20 mA		3.2	3.6	V
luminous intensity [Iv]	at If=20 mA	200	600		mcd
chromacity coordinates	at If=20 mA    white	X 0.285 Y 0.287	0.28 0.29	0.287 0.295	
reverse current [Ir]	at Vr=5 V			1	µA
viewing angle [2θ1/2]	at If=20 mA		30		deg

## LED ELECTRO-OPTICAL CHARACTERISTIC CURVES (WHITE)

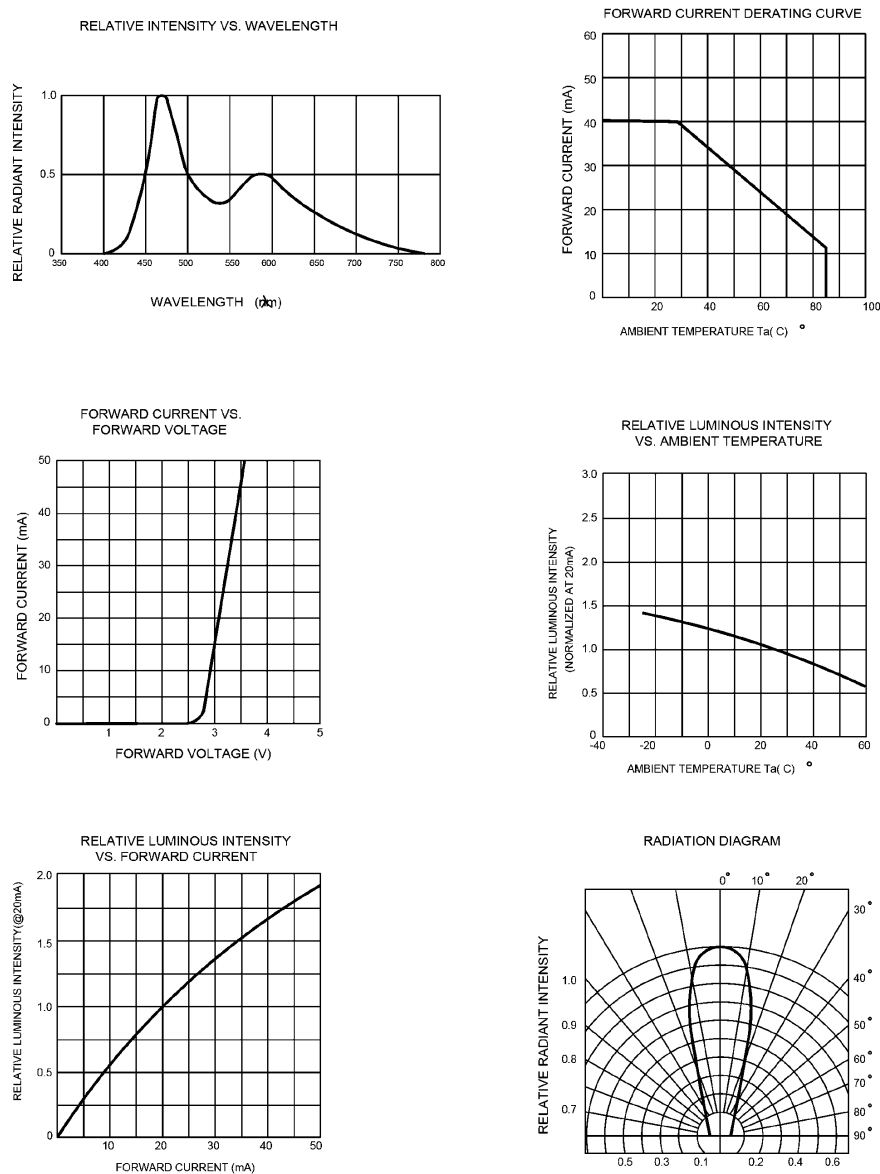

## LED ABSOLUTE MAXIMUM RATINGS (BLUE) (TA=25°C)

parameter	conditions/description	min	typ	max	units
power dissipation (Pd)				120	mW
DC forward current (If)				30	mA
peak forward current (Ifp)	pulse of 1/10 duty and 0.1 ms width			100	mA
reverse voltage (Vr)				5	V

## LED ELECTRO-OPTICAL CHARACTERISTICS (BLUE) (TA=25°C)

parameter	conditions/description	min	typ	max	units
forward voltage (Vf)	at If=20 mA		3.0	3.2	V
luminous intensity (Iv)	at If=20 mA	1,000	1,400		mcd
peak wavelength (λp)	at If=20 mA		460		nm
dominant wave length (λd)	at If=20 mA	465		470	nm
spectral line half-width (Δλ)	at If=20 mA		30		nm
viewing angle (2θ1/2)	at If=20 mA		30		deg

## LED ELECTRO-OPTICAL CHARACTERISTIC CURVES (BLUE)

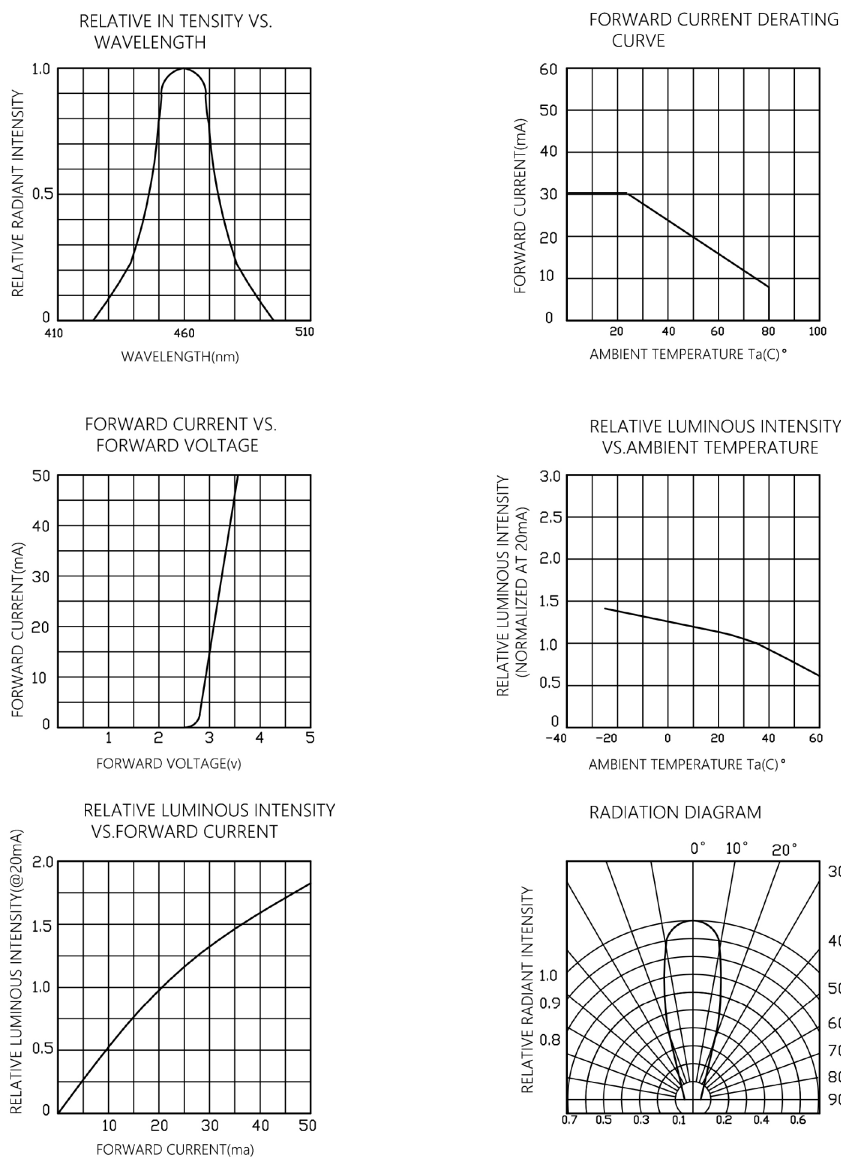

## LED ABSOLUTE MAXIMUM RATINGS (RED) (TA=25°C)

parameter	conditions/description	min	typ	max	units
power dissipation [Pd]				52	mW
DC forward current [IF]				20	mA
peak forward current [IFP]	pulse of 1/10 duty and 0.1 ms width			100	mA
reverse voltage [VR]				5	V

## LED ELECTRO-OPTICAL CHARACTERISTICS (RED) (TA=25°C)

parameter	conditions/description	min	typ	max	units
forward voltage [Vf]	at IF=20 mA		2.0	2.6	V
luminous intensity [Iv]	at IF=20 mA	2,600	3,000		mcd
reverse current [IR]	at VR=5 V			100	µA
peak wavelength [λp]	at IF=20 mA		622		nm
dominant wave length [λd]	at IF=20 mA	620		625	nm
spectral line half-width [Δλ]	at IF=20 mA		20		nm
viewing angle [2θ1/2]	at IF=20 mA		30		deg

## LED ELECTRO-OPTICAL CHARACTERISTIC CURVES (RED)

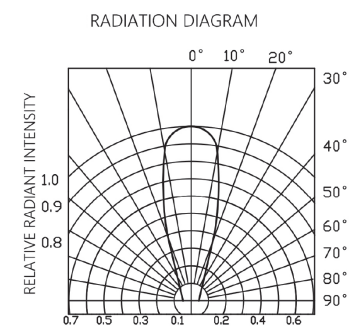
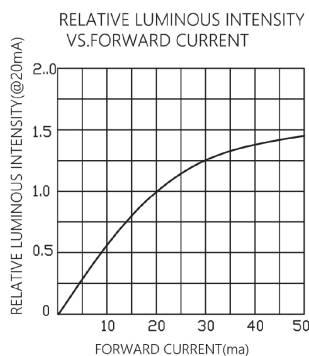
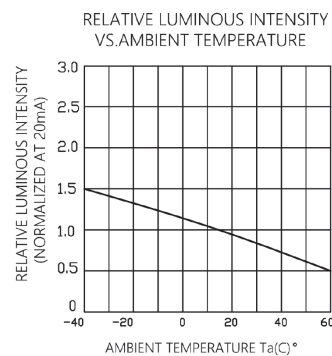
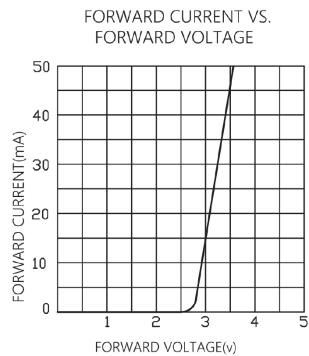
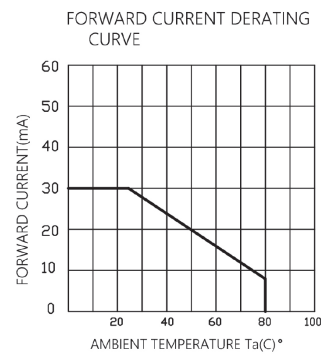
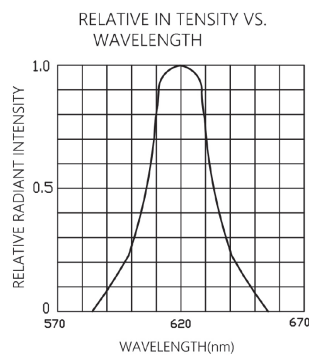

## LED ABSOLUTE MAXIMUM RATINGS (GREEN) (TA=25°C)

parameter	conditions/description	min	typ	max	units
power dissipation [Pd]				72	mW
DC forward current [If]				20	mA
peak forward current [Ifp]	pulse of 1/10 duty and 0.1 ms width			100	mA
reverse voltage [VR]				5	V

## LED ELECTRO-OPTICAL CHARACTERISTICS (GREEN) (TA=25°C)

parameter	conditions/description	min	typ	max	units
forward voltage [Vf]	at If=20 mA		3.2	3.6	V
luminous intensity [Iv]	at If=20 mA	14,500	15,000		mcd
reverse current [Ir]	at VR=5 V			1	µA
peak wavelength [λp]	at If=20 mA		515		nm
dominant wave length [λd]	at If=20 mA	510		525	nm
spectral line half-width [Δλ]	at If=20 mA		30		nm
viewing angle [2θ1/2]	at If=20 mA		30		deg

## LED ELECTRO-OPTICAL CHARACTERISTIC CURVES (GREEN)

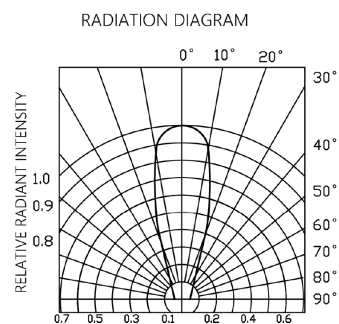
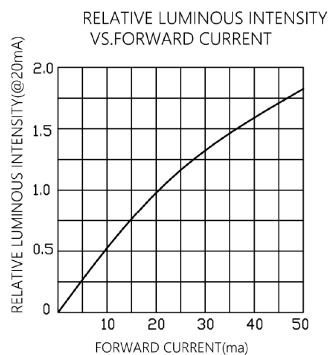
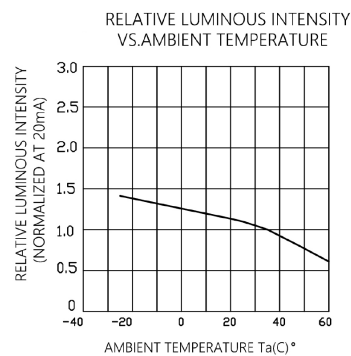
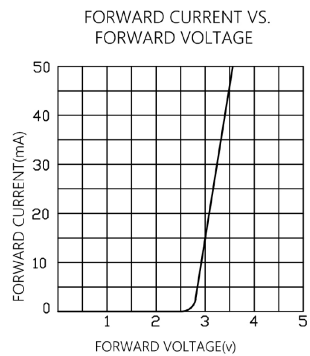
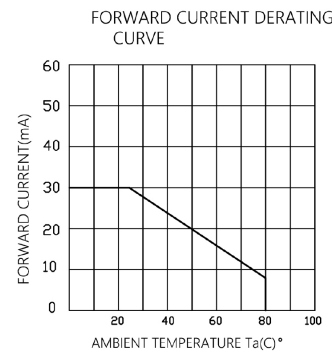
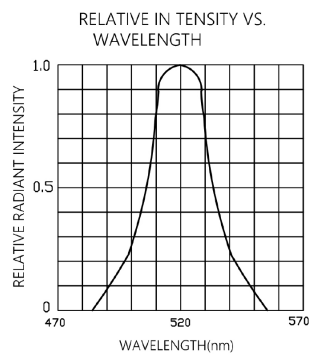

## LED ABSOLUTE MAXIMUM RATINGS (YELLOW) (TA=25°C)

parameter	conditions/description	min	typ	max	units
power dissipation [Pd]				60	mW
DC forward current [If]				20	mA
peak forward current [Ifp]	pulse of 1/10 duty and 0.1 ms width			100	mA
reverse voltage [Vr]				5	V

## LED ELECTRO-OPTICAL CHARACTERISTICS (YELLOW) (TA=25°C)

parameter	conditions/description	min	typ	max	units
forward voltage [Vf]	at If=20 mA		2.0	2.3	V
luminous intensity [Iv]	at If=20 mA	500	800		mcd
peak wavelength [λp]	at If=20 mA		589		nm
dominant wave length [λd]	at If=20 mA	587	590	593	nm
spectral line half-width [Δλ]	at If=20 mA		30		nm
viewing angle [2θ1/2]	at If=20 mA		30		deg

## LED ELECTRO-OPTICAL CHARACTERISTIC CURVES (YELLOW)

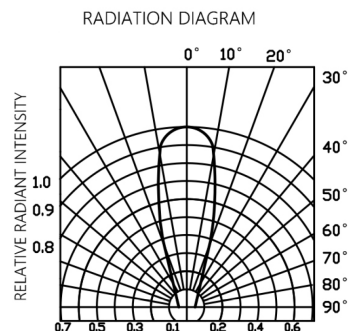
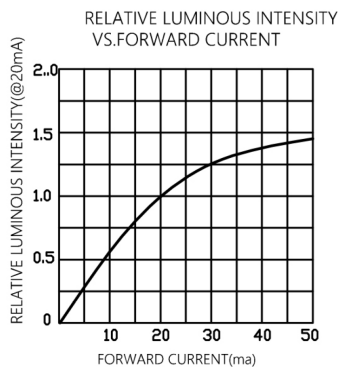
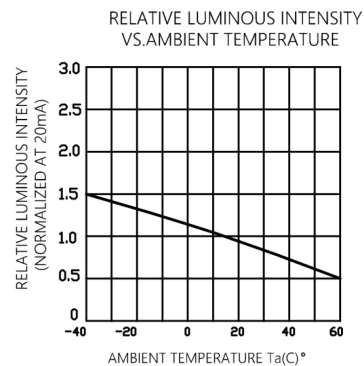
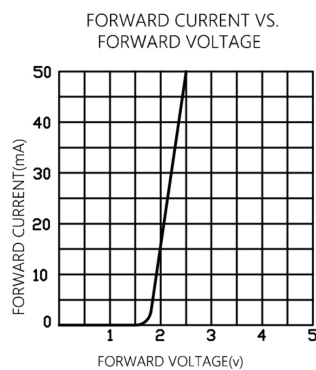
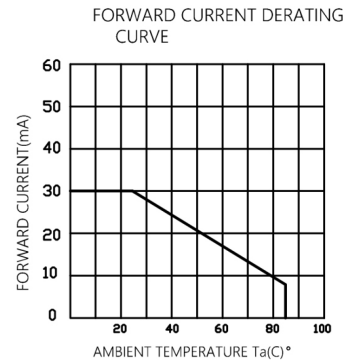
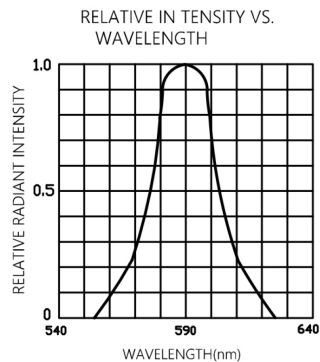

## MECHANICAL DRAWING

units: mm  
 tolerance:  $\pm 0.4$  mm  
 unless otherwise noted

ITEM	DESCRIPTION	MATERIAL	PLATING/COLOR
1	terminals	H62	silver
2	base	PA66 (UL94HB)	black
3	contacts	SUS	silver
4	burrn pad	PA66 (UL94HB)	black
5	LED		see part number key
6	cover	PA66 (UL94HB)	white
7	stem	PC (UL94HB)	red

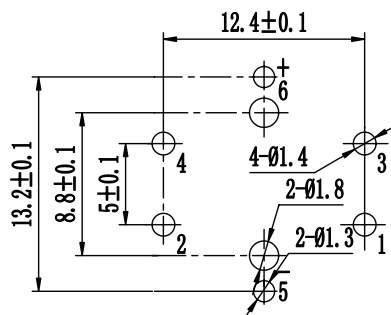
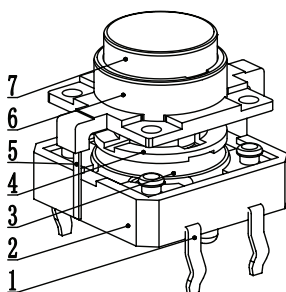
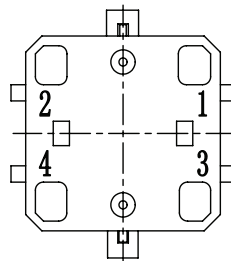
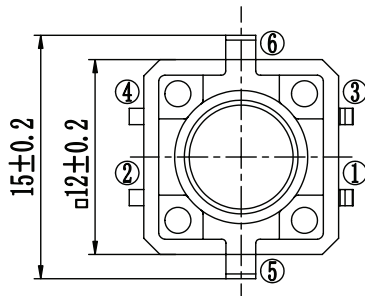
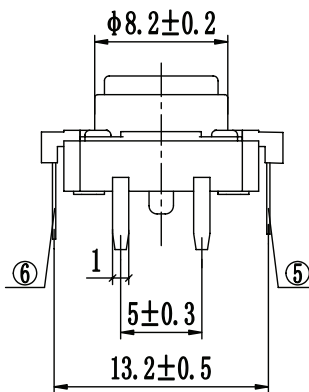
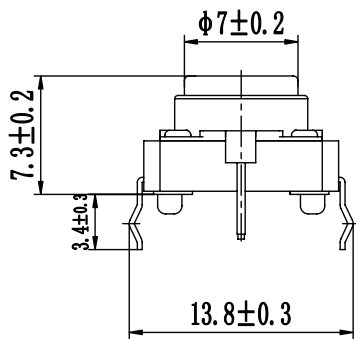
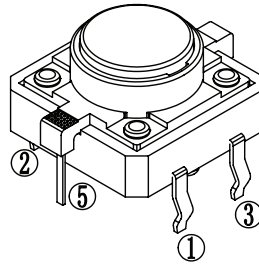

Recommended PCB Layout  
 Top View

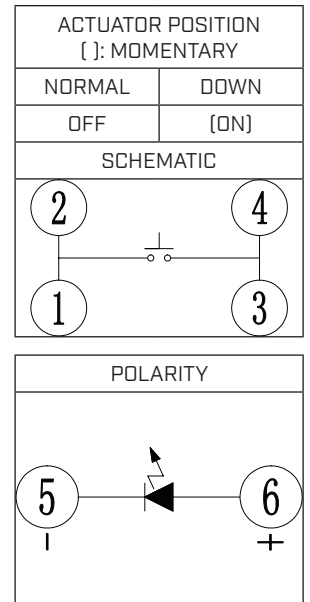

## PACKAGING

units: mm

Inner Bag Size: 190 x 195 mm  
Inner Bag QTY: 100 pcs per box  
Carton Size: 430 x 340 x 350 mm  
Carton QTY: 7,500 pcs per carton

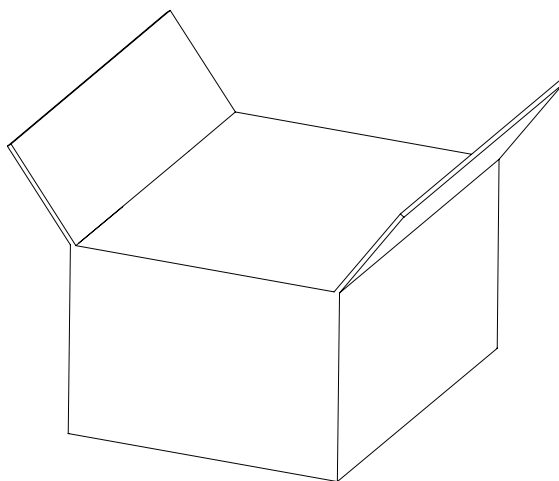
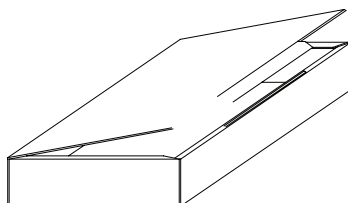



## REVISION HISTORY

rev.	description	date
1.0	initial release	06/14/2023

The revision history provided is for informational purposes only and is believed to be accurate.



CUI Devices offers a one (1) year limited warranty. Complete warranty information is listed on our website.

CUI Devices reserves the right to make changes to the product at any time without notice. Information provided by CUI Devices is believed to be accurate and reliable. However, no responsibility is assumed by CUI Devices for its use, nor for any infringements of patents or other rights of third parties which may result from its use.

CUI Devices products are not authorized or warranted for use as critical components in equipment that requires an extremely high level of reliability. A critical component is any component of a life support device or system whose failure to perform can be reasonably expected to cause the failure of the life support device or system, or to affect its safety or effectiveness.

[cuidevices.com](http://cuidevices.com)