

**MODEL:** CTW-3414-204SE | **DESCRIPTION:** TWEETER**FEATURES**

- tweeter
- Fo 1600 Hz
- polyester diaphragm

**SPECIFICATIONS**

parameter	conditions/description	min	typ	max	units
input power			20.0	25.0	W
impedance	DCR at 4 kHz, 1 W	3.162 3.4	3.400 4.0	3.638 4.6	$\Omega$ $\Omega$
resonant frequency (Fo)	at 1.0 W	1,280	1,600	1,920	Hz
frequency response		Fo		20,000	Hz
sound pressure level	at 1.0 W, 1 m, ave at 2.0, 3.0, 4.0, 6.0 kHz	82	85	88	dB
distortion	at 2.0 kHz, 1.0 W			10	%
pure sound detection	input signal: sine wave from 1,500 to 5,000 Hz for 3 seconds/2 cycles		2.0		V
polarity	cone moves backwards w/ positive dc current to "+" terminal				
dimensions	48.3 x 34.0 x 13.5				mm
magnet	Nd-Fe-B				
frame material	ABS				
cone material	polyester				
terminal	solder terminals				
weight		26.55	29.50	32.45	g
operating temperature		-25		55	$^{\circ}\text{C}$
storage temperature		-25		55	$^{\circ}\text{C}$
hand soldering	for maximum 3 seconds	350	380	410	$^{\circ}\text{C}$
RoHS	yes				

Notes: 1. All specifications measured at 20 $\pm$ 2 $^{\circ}\text{C}$ , humidity at 63-67%, under 86-106 kPa pressure, unless otherwise noted.

## MECHANICAL DRAWING

units: mm  
tolerance:  $\pm 0.5$  mm  
unless otherwise noted

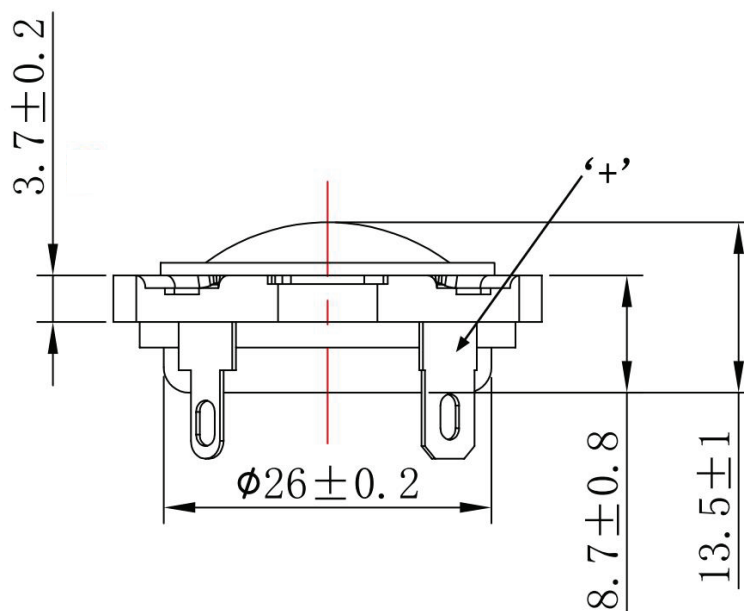
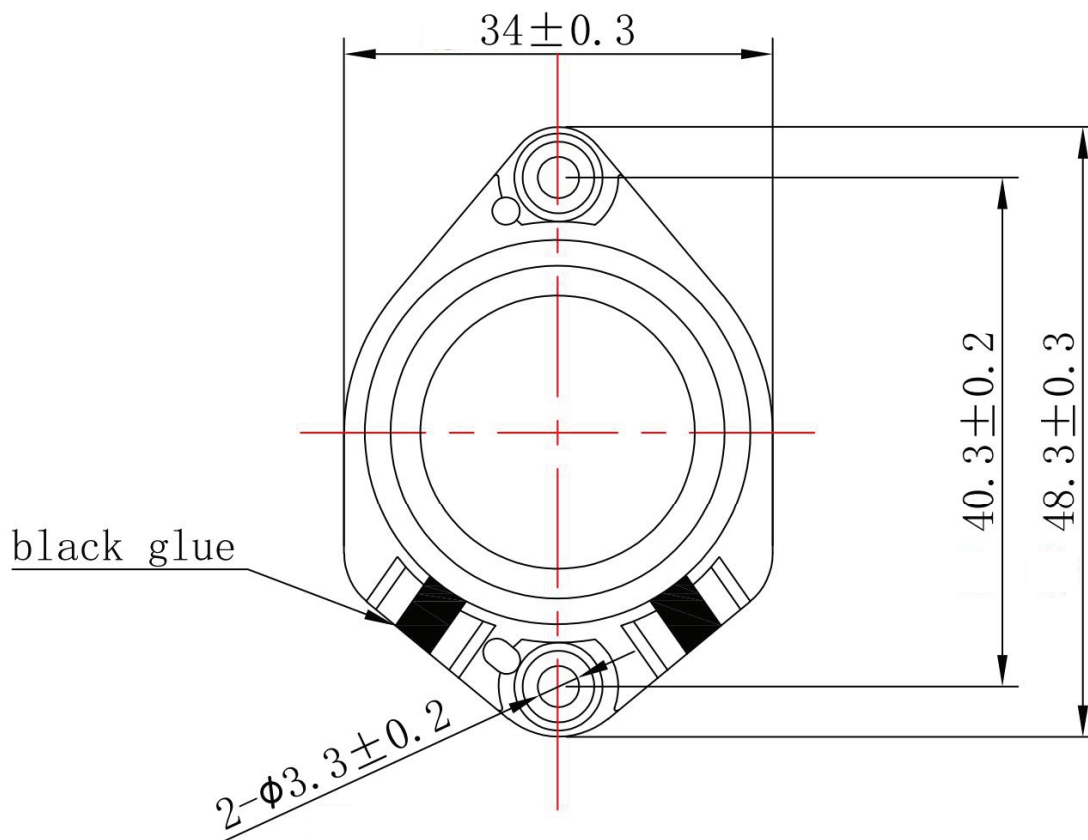

## RESPONSE CURVES

### Frequency Response Curve

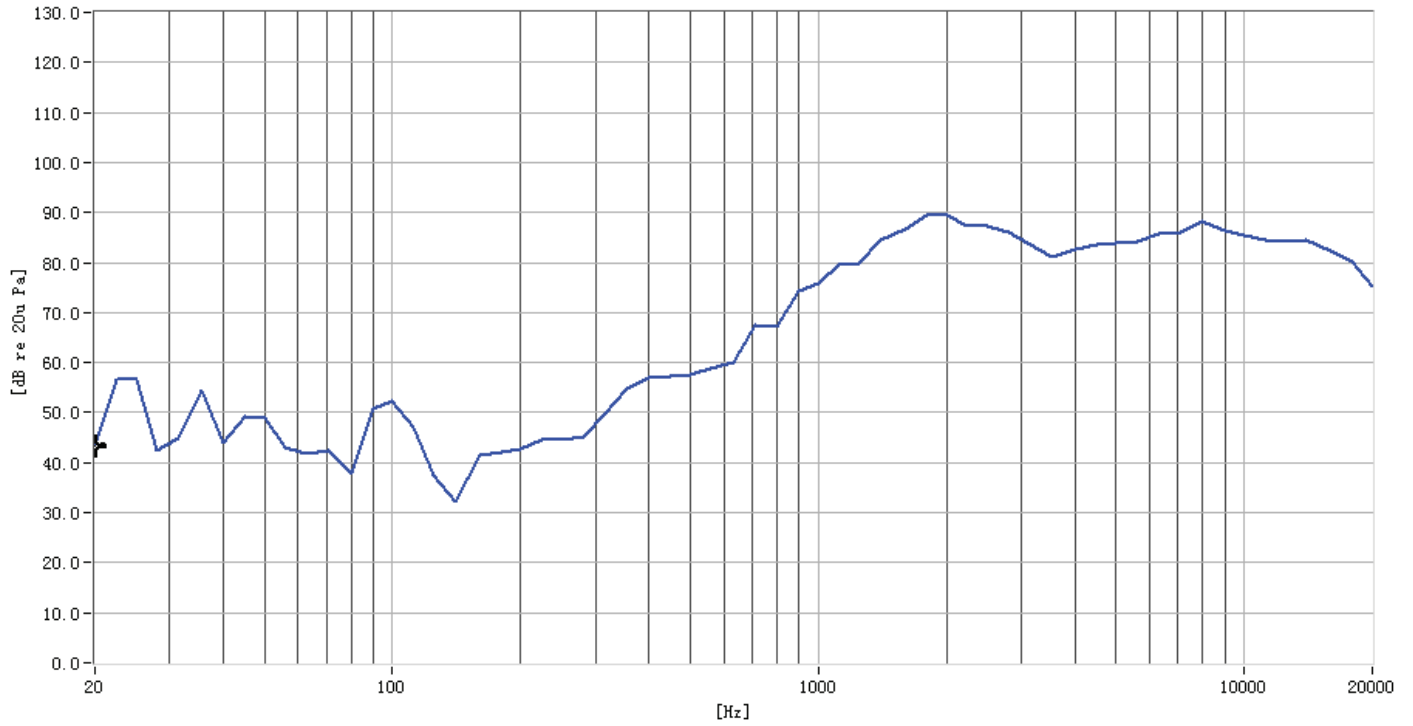

### Total Harmonic Distortion Curve

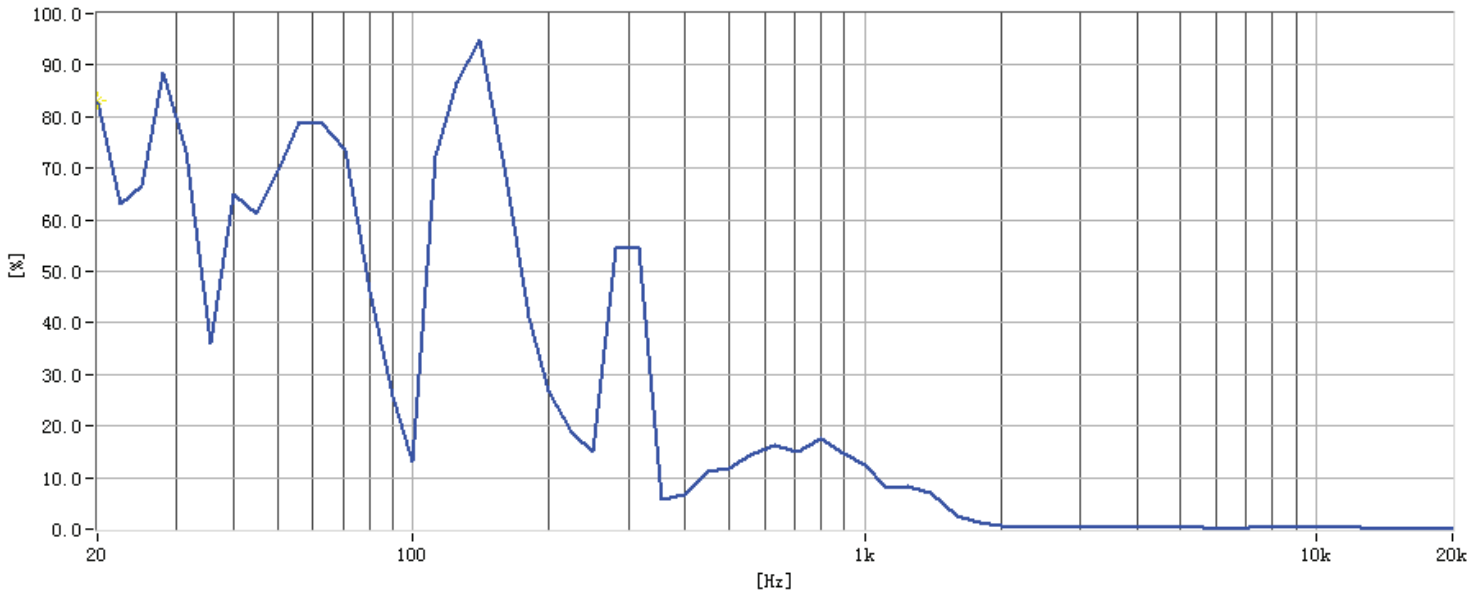

## REVISION HISTORY

rev.	description	date
1.0	initial release	04/23/2024

The revision history provided is for informational purposes only and is believed to be accurate.



CUI Devices offers a one (1) year limited warranty. Complete warranty information is listed on our website.

CUI Devices reserves the right to make changes to the product at any time without notice. Information provided by CUI Devices is believed to be accurate and reliable. However, no responsibility is assumed by CUI Devices for its use, nor for any infringements of patents or other rights of third parties which may result from its use.

CUI Devices products are not authorized or warranted for use as critical components in equipment that requires an extremely high level of reliability. A critical component is any component of a life support device or system whose failure to perform can be reasonably expected to cause the failure of the life support device or system, or to affect its safety or effectiveness.

[cuidevices.com](http://cuidevices.com)