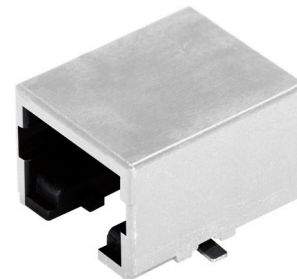

MODEL: CRJ053-1H-TH | **DESCRIPTION:** MODULAR JACK**FEATURES**

- 6P4C (RJ13)
- shielded
- high temp plastic

**SPECIFICATIONS**

parameter	conditions/description	min	typ	max	units
rated voltage				150	Vac
rated current				1.5	A
withstanding voltage	for 1 minute		1,500		Vac
contact resistance				40	mΩ
insulation resistance		500			MΩ
insertion/withdrawal force				6.12	kgf
operating temperature		0		70	°C
storage temperature		-40		80	°C
life			1,000		cycles
flammability rating	UL94V-0				
RoHS	yes				
packaging	carton size: 400 x 303 x 258 mm tray QTY: 120 pcs per tray carton QTY: 1,200 pcs per carton				

SOLDERABILITY

parameter	conditions/description	min	typ	max	units
reflow soldering	for maximum 5 seconds			260	°C

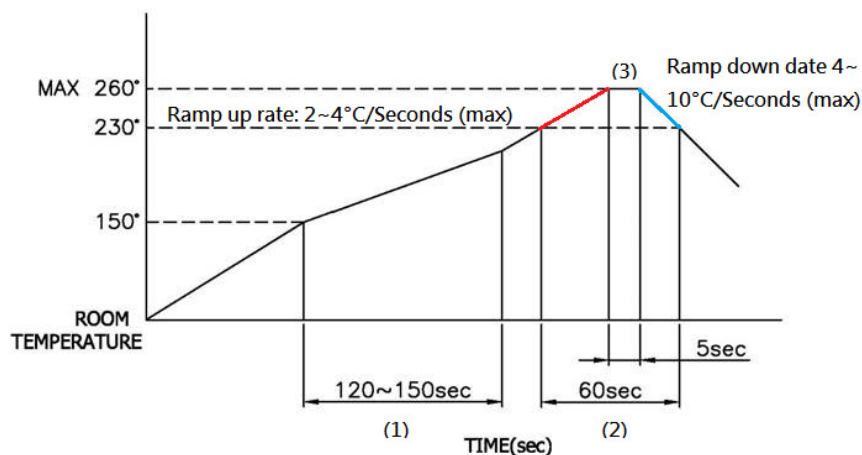

MECHANICAL DRAWING

units: mm
 tolerance:
 X ±0.5 mm
 X.X ±0.38 mm
 X.XX ±0.25 mm
 X.XXX ±0.10 mm
 PCB: ±0.05 mm
 PCB thickness: 1.6 mm
 unless otherwise noted

ITEM	DESCRIPTION	MATERIAL	PLATING/COLOR
1	insulator	PA9T [UL94V-0]	black
2	contact terminals	phosphor bronze	contact area: 6 μ" gold over nickel solder area: tin over nickel
3	shield	brass	nickel alloy

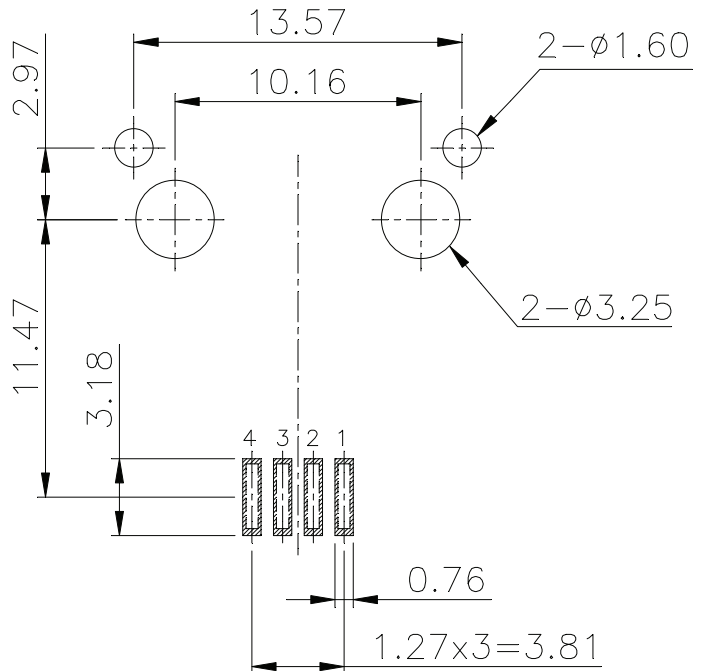
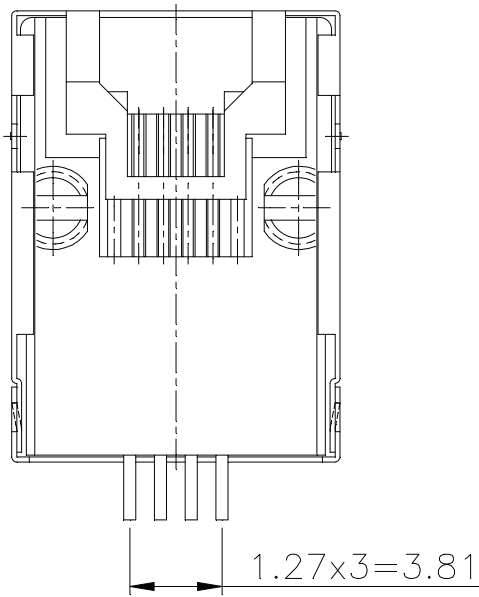
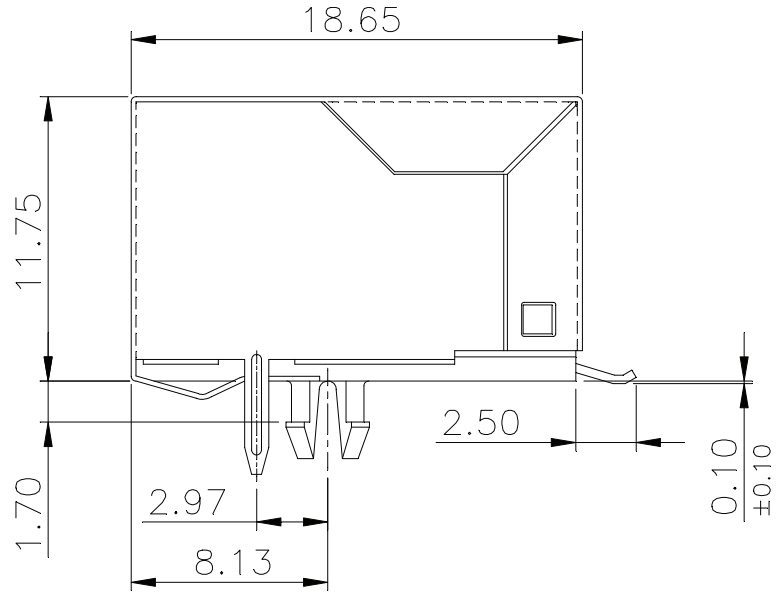
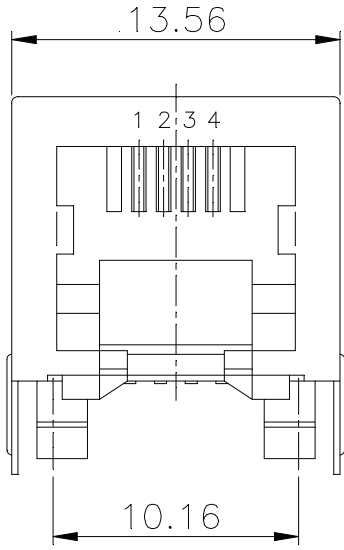

Recommended PCB Layout
 Top View

REVISION HISTORY

rev.	description	date
1.0	initial release	04/16/2021
1.01	logo, datasheet style update	08/05/2022

The revision history provided is for informational purposes only and is believed to be accurate.



CUI Devices offers a one (1) year limited warranty. Complete warranty information is listed on our website.

CUI Devices reserves the right to make changes to the product at any time without notice. Information provided by CUI Devices is believed to be accurate and reliable. However, no responsibility is assumed by CUI Devices for its use, nor for any infringements of patents or other rights of third parties which may result from its use.

CUI Devices products are not authorized or warranted for use as critical components in equipment that requires an extremely high level of reliability. A critical component is any component of a life support device or system whose failure to perform can be reasonably expected to cause the failure of the life support device or system, or to affect its safety or effectiveness.

cuidevices.com