

SERIES: CFM-40C | **DESCRIPTION:** DC AXIAL FAN**FEATURES**

- omniCOOL™ bearing system
- 40 x 40 mm frame
- multiple speed options
- PWM/tachometer wires available



| MODEL | input voltage | | input current ¹ | input power ¹ | rated speed ¹ | airflow ² | static pressure ³ | noise ⁴ |
|-------------------|---------------|-------------|----------------------------|--------------------------|--------------------------|----------------------|------------------------------|--------------------|
| | rated (Vdc) | range (Vdc) | max (A) | max (W) | typ (RPM±15%) | (CFM) | (inch H ₂ O) | typ (dBA) |
| CFM-4010C-050-195 | 5 | 4.5~5.5 | 0.08 | 0.40 | 5,000 ⁵ | 4.22 | 0.07 | 19.5 |
| CFM-4010C-065-251 | 5 | 4.5~5.5 | 0.17 | 0.85 | 6,500 | 5.49 | 0.11 | 25.1 |
| CFM-4010C-080-296 | 5 | 4.5~5.5 | 0.24 | 1.20 | 8,000 | 6.76 | 0.17 | 29.6 |
| CFM-4010C-150-195 | 12 | 10.8~13.2 | 0.05 | 0.60 | 5,000 ⁵ | 4.22 | 0.07 | 19.5 |
| CFM-4010C-165-251 | 12 | 10.8~13.2 | 0.06 | 0.72 | 6,500 | 5.49 | 0.11 | 25.1 |
| CFM-4010C-180-296 | 12 | 10.8~13.2 | 0.09 | 1.08 | 8,000 | 6.76 | 0.17 | 29.6 |
| CFM-4010C-250-195 | 24 | 21.6~26.4 | 0.05 | 1.20 | 5,000 ⁶ | 4.22 | 0.07 | 19.5 |
| CFM-4010C-265-251 | 24 | 21.6~26.4 | 0.05 | 1.20 | 6,500 | 5.49 | 0.11 | 25.1 |
| CFM-4010C-280-296 | 24 | 21.6~26.4 | 0.06 | 1.44 | 8,000 | 6.76 | 0.17 | 29.6 |

- Notes:
1. At rated voltage, after 3 minutes.
 2. At rated voltage, room temperature, 65% humidity, 0 inch H₂O static pressure.
 3. At rated voltage, 0 CFM airflow.
 4. Measured in an anechoic chamber as per ISO3745/GB4214-84 at rated voltage, with background noise 20±2 dBA at 1 m from the fan intake.
 5. Typical rated speed is measured as RPM±18% at rated voltage.
 6. Typical rated speed is measured as RPM±14% at rated voltage.
 7. All specifications are measured at 25°C, 65% relative humidity unless otherwise specified.

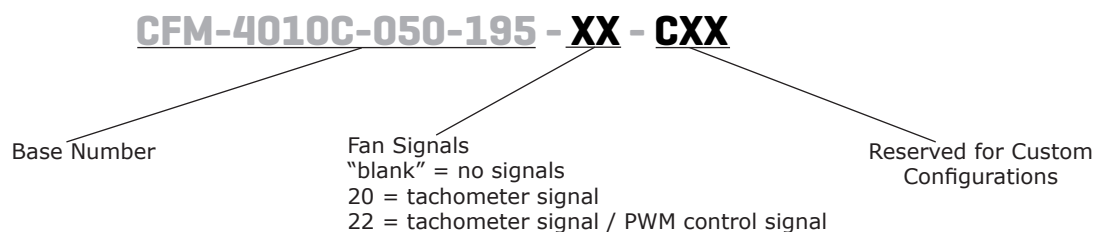
PART NUMBER KEY

INPUT

| parameter | conditions/description | min | typ | max | units |
|--------------------------------------|------------------------|------|------|------|-------|
| operating input voltage ⁸ | 5 Vdc input models | 4.5 | 5 | 5.5 | Vdc |
| | 12 Vdc input models | 10.8 | 12 | 13.2 | Vdc |
| | 24 Vdc input models | 21.6 | 24 | 26.4 | Vdc |
| starting voltage | 5 Vdc input models | | 3.5 | | Vdc |
| | 12 Vdc input models | | 7.0 | | Vdc |
| | 24 Vdc input models | | 14.0 | | Vdc |

Note: 8. See Model section on page 1 for specific input voltage ranges.

PERFORMANCE⁹

| parameter | conditions/description | min | typ | max | units |
|-----------------|--|-------|-----|-------|-----------------------|
| rated speed | at rated voltage, 25°C, after 3 minutes | 5,000 | | 8,000 | RPM |
| air flow | at 0 inch H ₂ O, see performance curves | 4.22 | | 6.76 | CFM |
| static pressure | at 0 CFM, see performance curves | 0.07 | | 0.17 | inch H ₂ O |
| noise | at 1 m, rated speed | 19.5 | | 29.6 | dBA |

Note: 9. See Model section on page 1 for specific values.

PROTECTIONS / FEATURES¹⁰

| parameter | conditions/description | min | typ | max | units |
|---------------------|-----------------------------------|-----|-----|-----|-------|
| polarity protection | on all models | | | | |
| tachometer signal | available on "20" and "22" models | | | | |
| PWM control signal | available on "22" models | | | | |

Notes: 10. See Application Notes for details.

SAFETY & COMPLIANCE

| parameter | conditions/description | min | typ | max | units |
|-----------------------|---|-----|--------|-----|-------|
| insulation resistance | at 500 Vdc between frame and positive terminal | 10 | | | MΩ |
| dielectric strength | at 500 Vac, 60 Hz, 1 minute between housing and positive terminal | | | 5 | mA |
| safety approvals | UL/cUL 507, TUV (EN/IEC 62368-1:2020+A11) | | | | |
| EMI/EMC | EN 55032:2015, EN 55035:2017 | | | | |
| life expectancy | at 40°C, 65% RH, 90% confidence level | | 40,000 | | hours |
| RoHS | yes | | | | |

ENVIRONMENTAL

| parameter | conditions/description | min | typ | max | units |
|-----------------------|------------------------|-----|-----|-----|-------|
| operating temperature | | -10 | | 70 | °C |
| storage temperature | | -40 | | 75 | °C |
| operating humidity | non-condensing | 35 | | 85 | % |
| storage humidity | non-condensing | 35 | | 85 | % |

PERFORMANCE CURVES

CFM-4010C-050-195

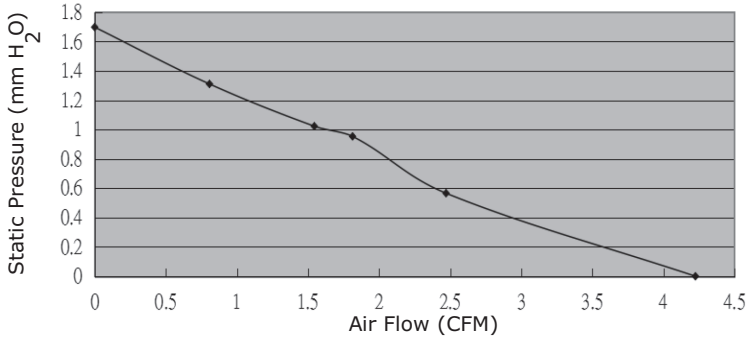

CFM-4010C-065-251

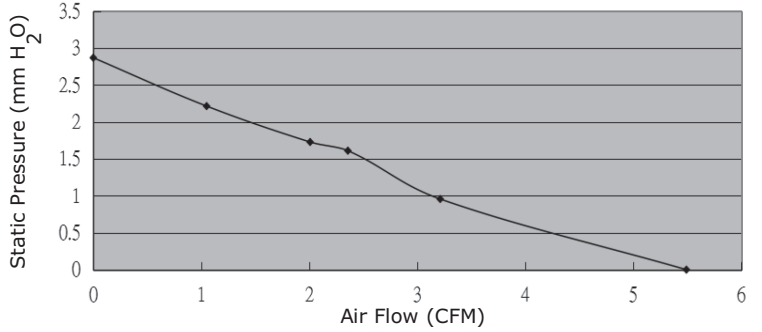

CFM-4010C-080-296

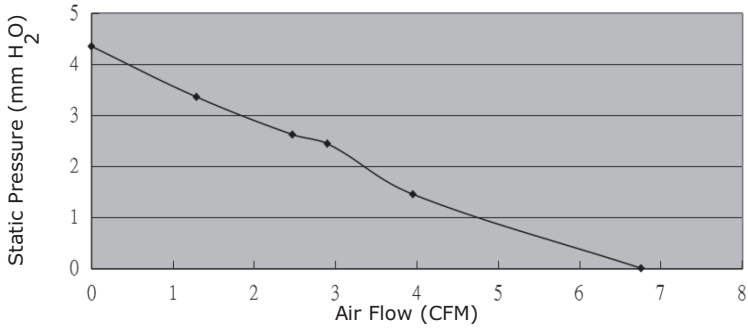

CFM-4010C-150-195

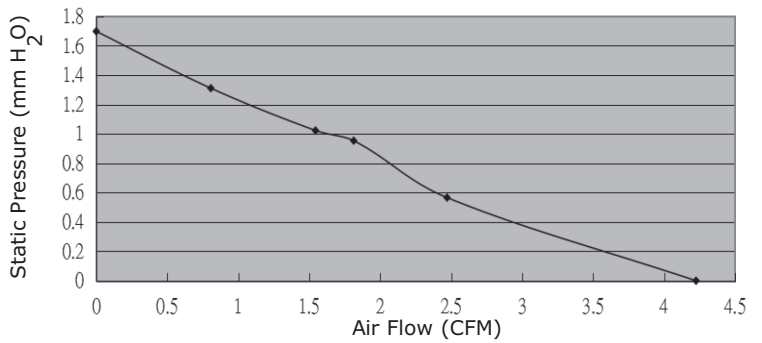

CFM-4010C-165-251

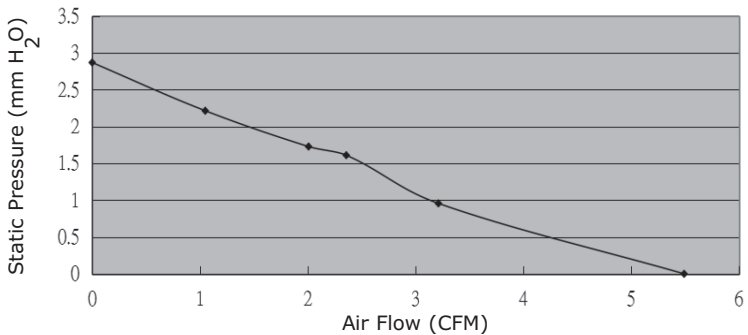

CFM-4010C-180-296

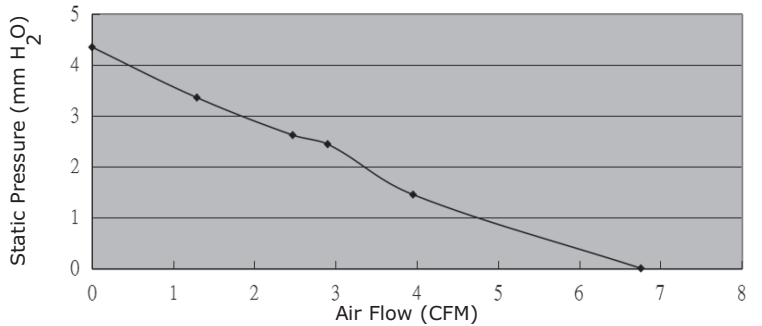

PERFORMANCE CURVES (CONTINUED)

CFM-4010C-250-195

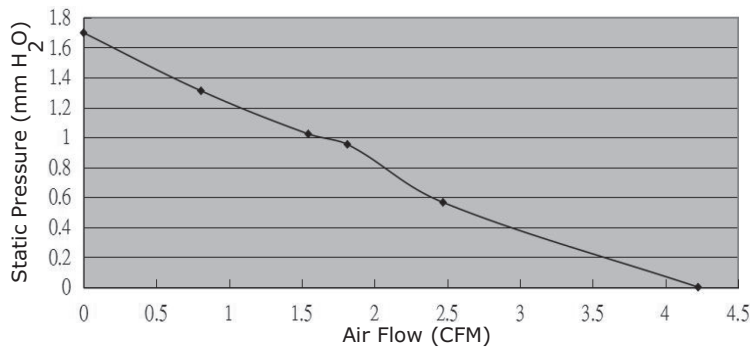

CFM-4010C-265-251

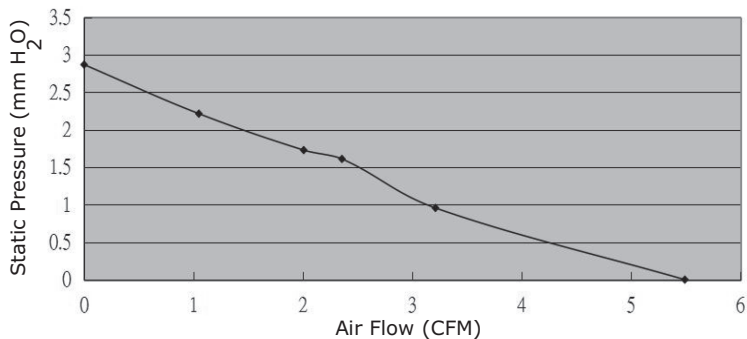

CFM-4010C-280-296

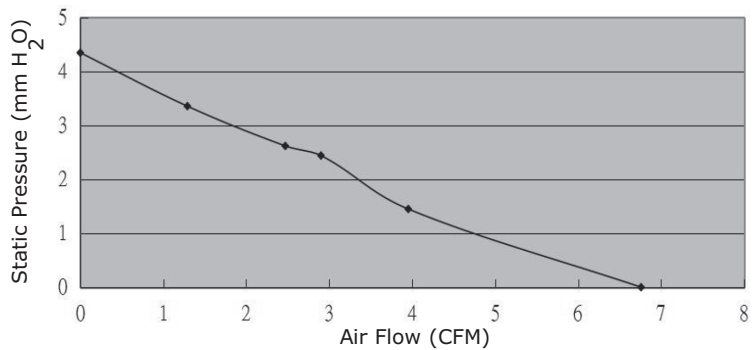

MECHANICAL

| parameter | conditions/description | min | typ | max | units |
|-----------------------|--|-----|------|-----|-------|
| motor | 4 pole DC brushless | | | | |
| bearing system | omniCOOL™ | | | | |
| direction of rotation | counter-clockwise viewed from front of fan blade | | | | |
| dimensions | 40 x 40 x 10.5 | | | | mm |
| material | PBT (UL94V-0) | | | | |
| weight | CFM-4010C-250-195 | | 13.0 | | g |
| | CFM-4010C-265-251 | | 13.6 | | g |
| | CFM-4010C-280-296 | | 12.6 | | g |
| | all other models | | 13.8 | | g |

MECHANICAL DRAWING

units: mm

2 wire versions (+Vin & -Vin): UL 1007, 26 AWG
 3 wire versions (+Vin, -Vin, & tach): UL 1061, 26 AWG
 4 wire versions (+Vin, -Vin, tach, & PWM): UL 1061, 28 AWG

| MOUNTING SCREW (Pan Head) | | | |
|---------------------------|------|----------------|------------|
| Screw Type | Size | Standard | Torque |
| Machine Screw | M3 | JIS B1111-1974 | 7.5 kgf-cm |

| WIRE CONNECTIONS | |
|----------------------|-------------|
| Wire Color | Function |
| Red | +Vin |
| Black | -Vin |
| Yellow ¹¹ | Tach Signal |
| Blue ¹¹ | PWM |

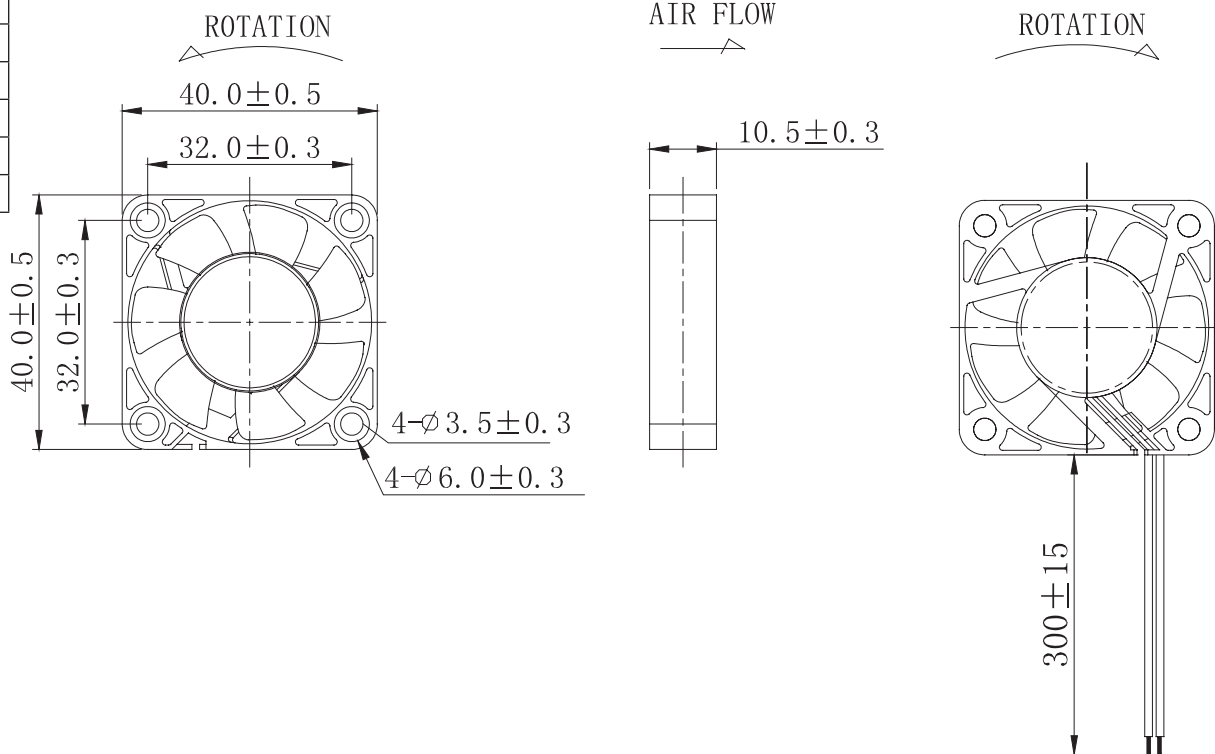

Notes: 11. Wires only present on versions with output signals.

APPLICATION NOTES

Polarity Protection

Able to withstand 10 minutes of reverse polarity connection between the positive and negative wires without causing damage.

Tachometer Signal (Yellow Wire)

The tachometer signal is for detecting the rotational speed of the fan motor. The output will be a square wave when fan is operating and V_{FG} or V_{CE} depending on the locked rotor position when fan motor is locked (See Figures 1~2 below).

Figure 1: Tachometer Output Circuit

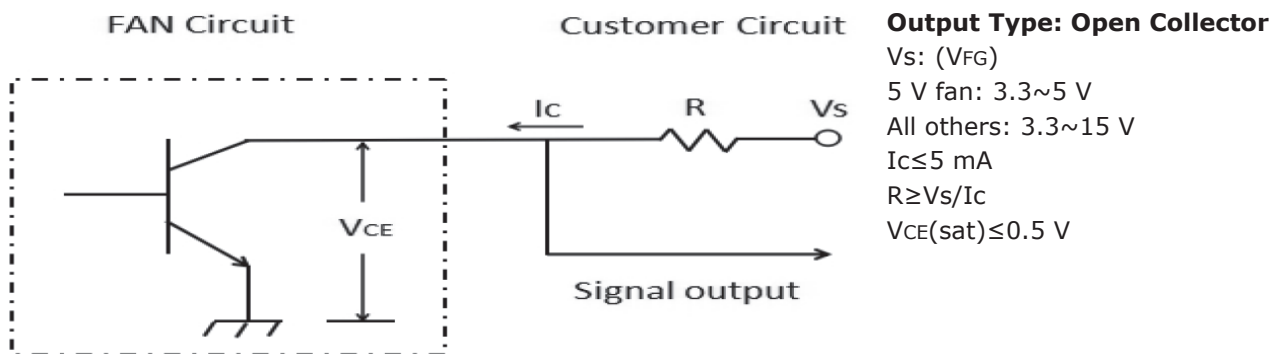
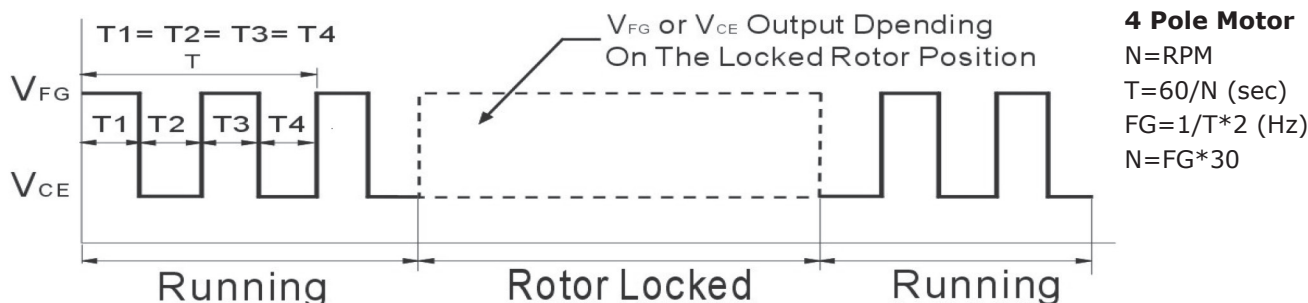

Figure 2: Tachometer Output Waveform



PWM Signal (Blue Wire)

This wire is for speed control of the fan motor using a PWM input signal from the customer circuit (See Figure 3 below).

Figure 3: PWM Input Signal

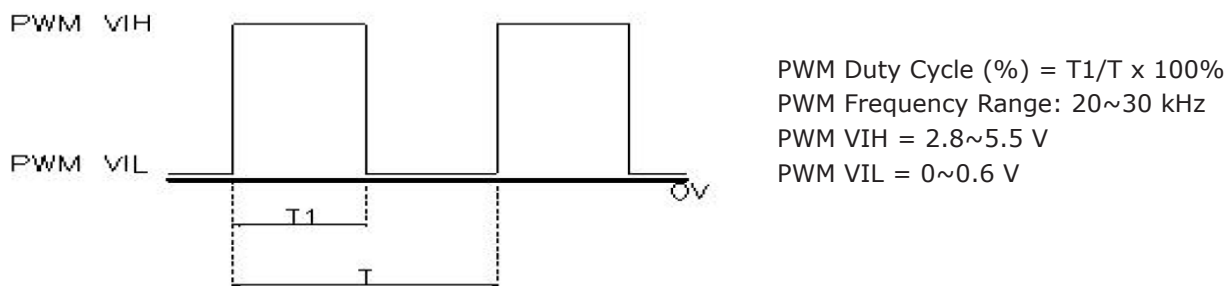

REVISION HISTORY

| rev. | description | date |
|------|---|------------|
| 1.0 | initial release | 05/12/2021 |
| 1.01 | added models CFM-4010C-250-195, CFM-4010C-265-251 and CFM-4010C-280-296 | 10/06/2021 |
| 1.02 | added wire details for 3 wire versions | 02/24/2022 |
| 1.03 | added PWM signal versions | 05/19/2022 |

The revision history provided is for informational purposes only and is believed to be accurate.

CUI DEVICES

CUI Devices offers a one (1) year limited warranty. Complete warranty information is listed on our website.

CUI Devices reserves the right to make changes to the product at any time without notice. Information provided by CUI Devices is believed to be accurate and reliable. However, no responsibility is assumed by CUI Devices for its use, nor for any infringements of patents or other rights of third parties which may result from its use.

CUI Devices products are not authorized or warranted for use as critical components in equipment that requires an extremely high level of reliability. A critical component is any component of a life support device or system whose failure to perform can be reasonably expected to cause the failure of the life support device or system, or to affect its safety or effectiveness.