

MODEL: CDM-13008 | **DESCRIPTION:** SPEAKER**FEATURES**

- metal frame
- PET cone

**SPECIFICATIONS**

parameter	conditions/description	min	typ	max	units
diameter			13		mm
depth			2.9		mm
input power	max. power: IEC-60268-5, filter 60 s on / 120 s off, 10 cycles at room temp		0.2	0.5	W
impedance	at 1.5 kHz, 1 V	6.8	8	9.2	Ω
resonant frequency	at 1 V	880	1100	1,320	Hz
sound pressure level	0.2 W, 10 cm ave. at 1.5, 2.0, 2.5, 3.0 kHz 1 W, 1 m ave. at 1.5, 2.0, 2.5, 3.0 kHz	84 71	87 74	90 77	dB dB
response				20,000	Hz
distortion	at 1.5 kHz, 0.2 W			5	%
buzz, rattle, etc.	must be normal at sine wave 1.26 V				
magnet size	size: 6.8 x 1.0 mm				
operating temperature		-20		55	$^{\circ}\text{C}$
weight			1.1		g
material	metal				
RoHS	yes				

SOLDERABILITY

parameter	conditions/description
hand soldering	370 \pm 10 $^{\circ}\text{C}$ for 3 \pm 1 seconds

MECHANICAL DRAWING

units: mm

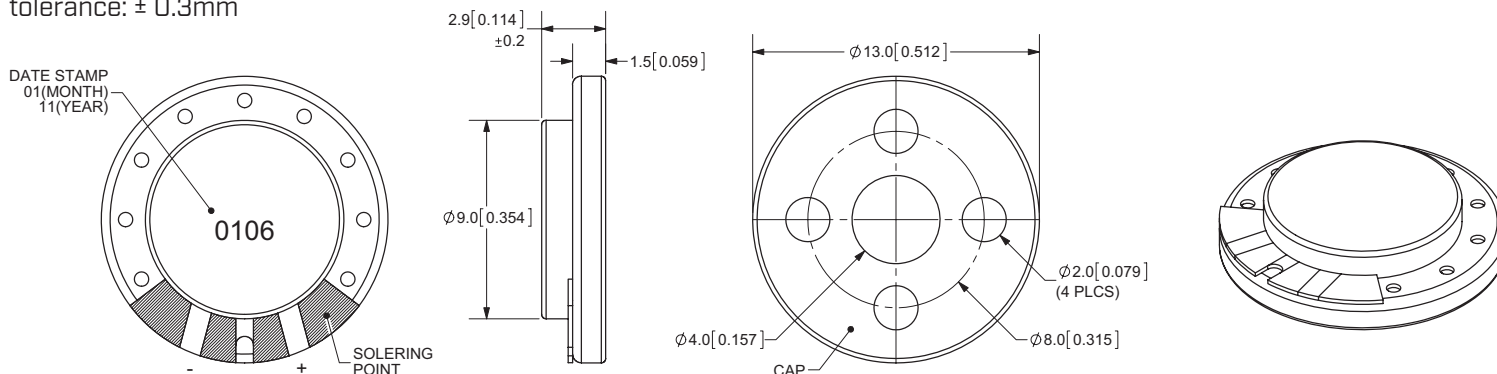
tolerance: \pm 0.3mm

FREQUENCY RESPONSE CURVE

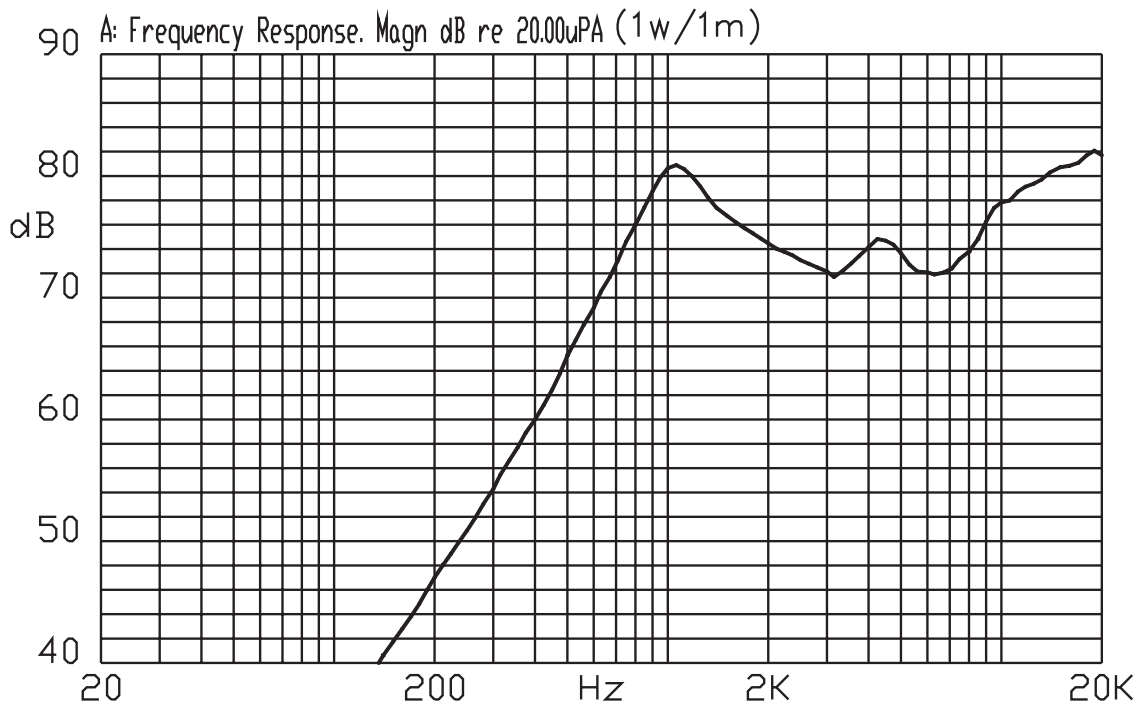
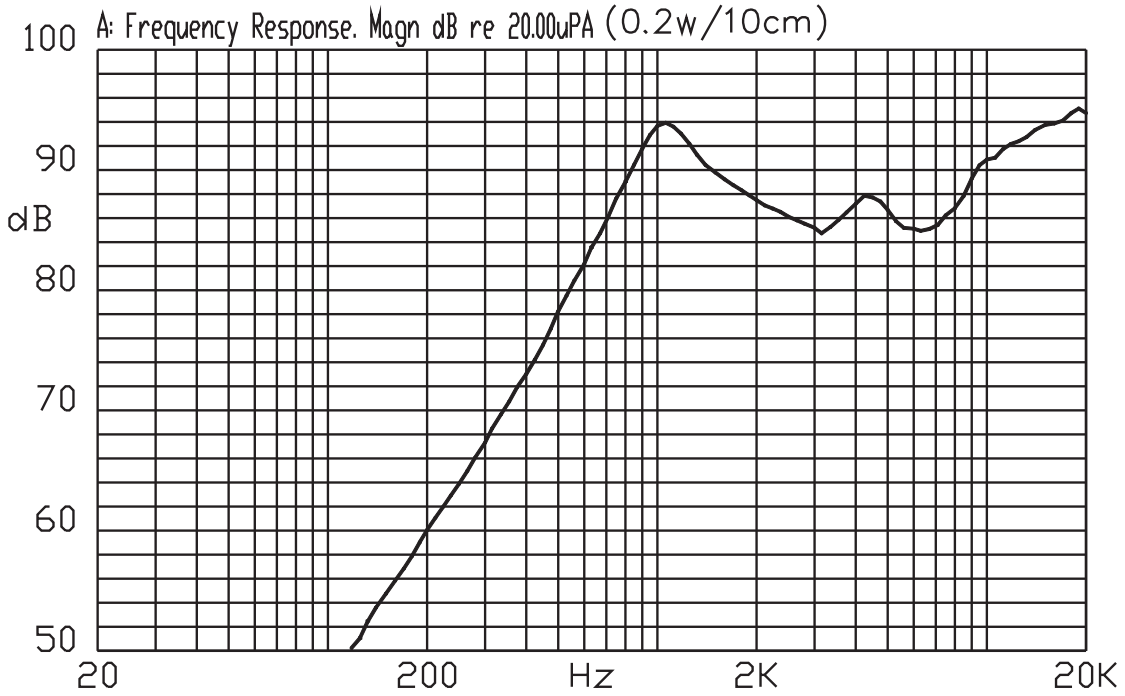

PACKAGING

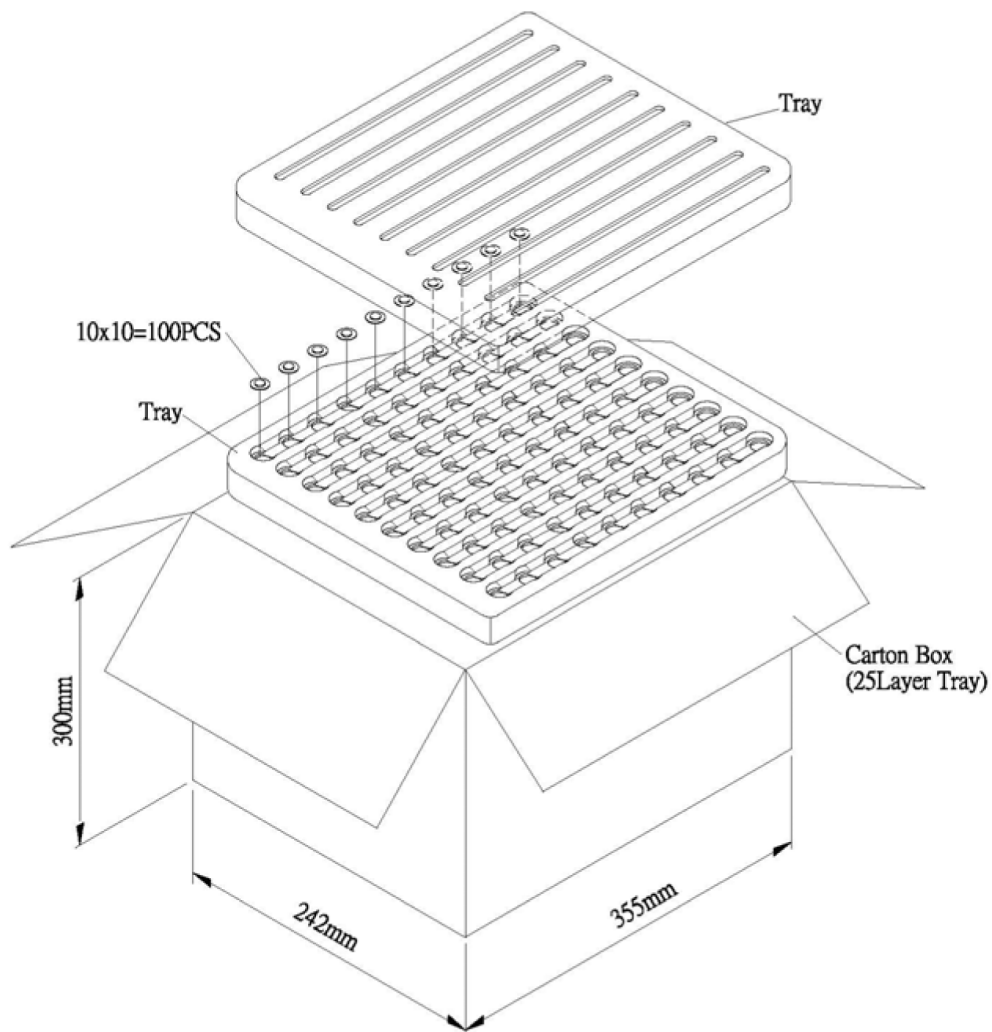

Tray	345mmx235mmx20mm	1x100PCS=100PCS
Carton Box	355mmx242mmx300mm	100PCSx25=2,500PCS

REVISION HISTORY

rev.	description	date
1.0	initial release	11/08/2011
1.01	brand update	01/20/2020
1.02	logo, datasheet style update	08/05/2022

The revision history provided is for informational purposes only and is believed to be accurate.



CUI Devices offers a one (1) year limited warranty. Complete warranty information is listed on our website.

CUI Devices reserves the right to make changes to the product at any time without notice. Information provided by CUI Devices is believed to be accurate and reliable. However, no responsibility is assumed by CUI Devices for its use, nor for any infringements of patents or other rights of third parties which may result from its use.

CUI Devices products are not authorized or warranted for use as critical components in equipment that requires an extremely high level of reliability. A critical component is any component of a life support device or system whose failure to perform can be reasonably expected to cause the failure of the life support device or system, or to affect its safety or effectiveness.

cuidevices.com